



RENAULT
Passion for life

Renault ZOE

Europe's Best Selling Electric Vehicle*



6th May 2021

5 YEAR
WARRANTY
100,000 MILES



ZOE

RENAULT

ZOE

ZOE
The future is here!



Revolutionary from the start...

Rediscover the pleasure of driving with ZOE. Experience cutting edge technology, over 200 miles of driving range and join the electric revolution.



2009

Renault unveil ZOE, Fluence Z.E, Kangoo Z.E. and Twizy concepts at the Frankfurt Motor show.



2012

Production version of ZOE unveiled at Geneva motor show. Kangoo Z.E voted international van of the year.



2015

New, more efficient R90 motor introduced, giving 149 miles NEDC⁽¹⁾ range.



2018

More powerful R110 motor introduced, offering even greater driving pleasure.



2011

Renault announce they will produce the Twizy and begin taking orders. Production of Fluence Z.E and Kangoo Z.E also begins.



2013

ZOE is available to buy in the UK.



2016

ZOE with Z.E. 40 battery is launched allowing a 186 mile WLTP⁽²⁾ range, setting a new milestone in the market of affordable electric vehicles.



2019

New ZOE is launched with a driving range of up to 245 miles⁽²⁾ and faster, more versatile charging options.

(1) Homologated range according to NEDC test cycle, for comparison purposes, 149 miles, and may not reflect real life driving results.

(2) PLAY R110 245 miles, ICONIC R110 and ICONIC R135 239 miles and GT LINE R135 238 miles. WLTP figures shown are for comparability purposes. Figures obtained after the battery was fully charged. Actual real-world driving results may vary depending on factors such as the starting charge of the battery, accessories fitted after registration, weather conditions, driving styles and vehicle load. Renault estimates average real-world driving figures for this vehicle as 233 miles in summer and 150 miles in winter, depending on the factors above.

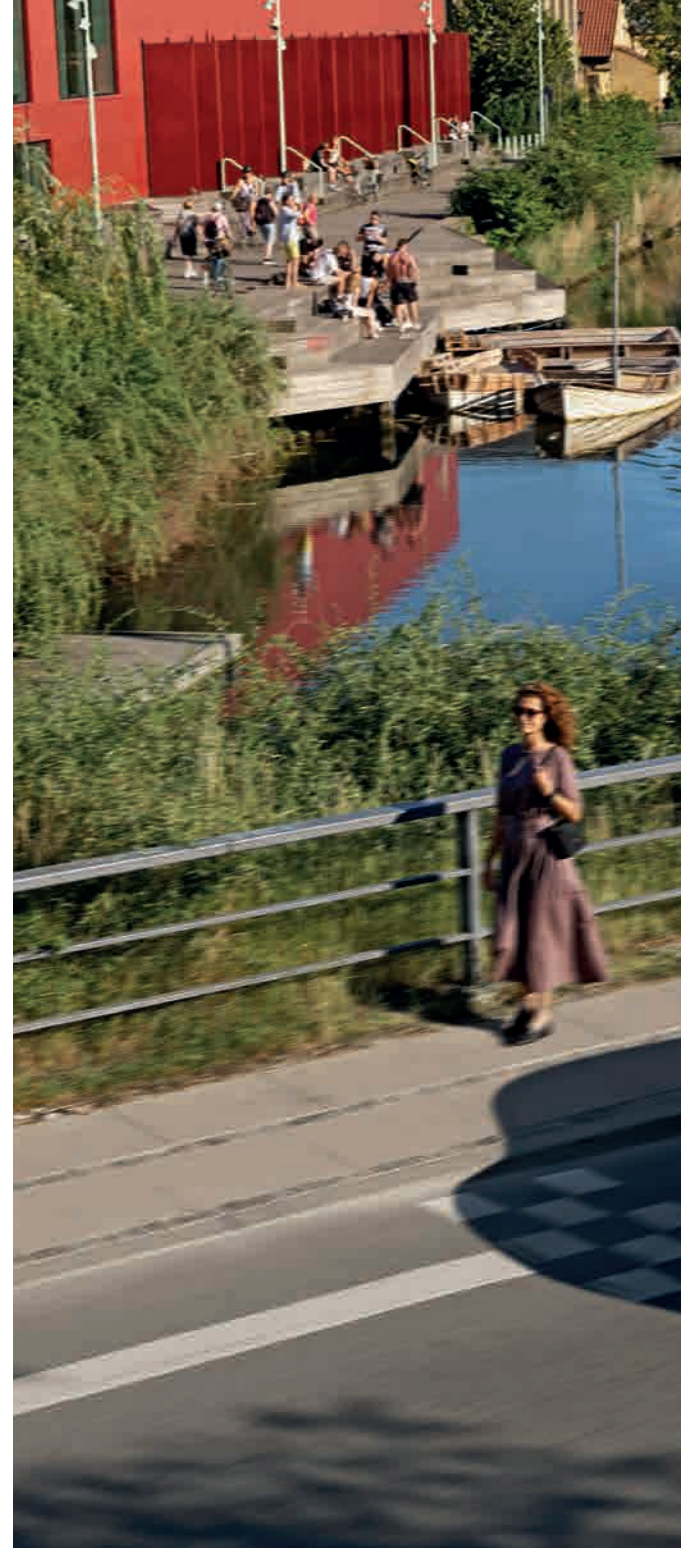



...and recognised for it



"(Range) – "isn't far off twice as much as the Honda e, and significantly more than the Corsa or 208"

TopGear

"It's quiet, smooth, practical and packed with tech, making it the best affordable EV on the market"



"Renault is still just about the most affordable way into a small, pure-electric family car"

Driving Electric

"The Zoe represents great value for money, especially against the heap of small electric cars due to hit the market soon, such as the Honda E and Mini Electric. These are also likely to cost close to £30,000, but offer considerably less range"



WhatCar



Renault Electric

Always a step ahead

Renault has been pushing the boundaries of innovation from revealing our first electric concept car in 2008, and since then has been a leader in electric vehicle manufacture in Europe. It has been a priority to fulfil our commitment and continue to develop our technology so that our vehicles stay at the forefront of the electric vehicle market. In 2016, we launched ZOE with the Z.E. 40 battery, with almost twice the capacity of the previous version and 2018 saw the introduction of the R110 motor, bringing ZOE more power than ever before. Finally, 2019 brought with it ZOE, with a 245⁽¹⁾ mile driving range, along with new faster and more versatile charging options.

First place on the track - first choice on the road

Our commitment to electric motoring innovation runs deeply in Renault's brand DNA. We were a founding partner in Formula E™, the FIA's newest race series. Winning the team championship in 2014/15 and 2015/16 seasons, along with the driver's championship in 2015/16, proves superior electric technology on the track and as one of Europe's best selling EV brands on the road.



(1) PLAY R110 245 miles, ICONIC R110 and ICONIC R135 239 miles and GT LINE R135 238 miles. WLTP figures shown are for comparability purposes. Figures obtained after the battery was fully charged. Actual real-world driving results may vary depending on factors such as the starting charge of the battery, accessories fitted after registration, weather conditions, driving styles and vehicle load. Renault estimates average real-world driving figures for this vehicle as 233 miles in summer and 150 miles in winter, depending on the factors above.

Easy Electric Life

Electric mobility does not have to be more complicated than fuel-powered cars.

Far from it, electric power comes as second nature in most areas of our lives - have you ever thought about filling up your smartphone with fuel? Your car does not need to be any different from your phone, simply put it on charge via a home wallbox⁽¹⁾ before you go to sleep and it will be ready for you in the morning.

The ZOE experience

We were amongst the first manufacturers to launch a range of affordable 100% electric vehicles.

We have years of experience helping customers to integrate electric vehicles into their lives, and we have a community of happy ZOE customers to prove it. We are now more than ready to make the electric revolution easy and accessible to everyone.

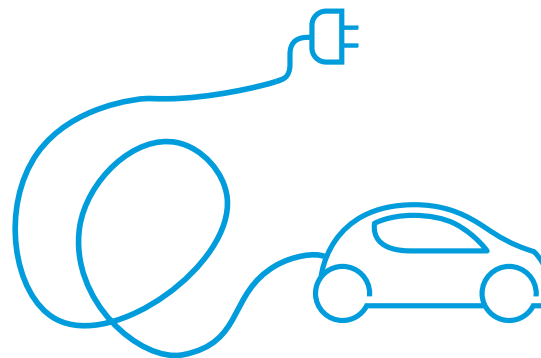

(1) Please see Wallbox page for more information



What makes ZOE so special?

No fuss, zero tailpipe emissions, easy to drive - these are all the things we love about electric vehicles and all the things that the ZOE stands for. There are many benefits to owning a ZOE, including:

Easy Electric Life. Renault make switching to electric easy. We provide you with all the basics you need to integrate ZOE into your life, including helping you with a home charging solution. There is nothing left to worry about!

Chameleon Charger™⁽¹⁾. Our innovative Chameleon Charger™ is unique to Renault and ensures your ZOE is always able to charge at the maximum power available to it, saving you time and making the most of any charging station whilst on the move or at home!

Truly connected. A connected life is no longer a thing of the future. Our Connected Services take communication between smartphone and car to another level, allowing features such as remote charging, monitoring of your charge status and pre-conditioning.⁽²⁾

Style. We all want style in our lives and ZOE gives you just that. With its distinctive design and expressive looks, ZOE has its very own electric identity.

Low running costs. Charging ZOE at home is not only easy but cost effective as well. With a full charge costing around £7.50⁽³⁾, you will start saving money, journey after journey!

Plug in Car Grant. ZOE qualifies for the Plug in Car Grant (PiCG) - a government grant of 35%, up to a maximum value of £2,500, towards the cost of a new ultra-low carbon car, which is provided to a consumer at the point of purchase. The grant is applied to the total retail price after discounts which includes the basic price, VAT, delivery and administration fees (this excludes first registration and any optional extras).

(1) For AC charging, between 3kW to 22kW.

(2) Features available on MY Renault, Connected. Services with valid subscription.

(3) Recharge cost £7.48, based on 9.25 hours of 14.4p per kWh (Source: UK Power). Full recharge of the 52kW battery.

Will ZOE suit my lifestyle?

At Renault we believe that the ZOE can be the perfect fit for a wide range of lifestyles, whether its for a daily commute, multiple short runs to the local school or shops or even long leisurely drives. Don't just take our word for it, this is what some of our customers have to say about their ZOE. Have a look at www.renault.co.uk to see the latest reviews!



John - Fort William **10/10**

- + *This is our second ZOE. Much improved car. Better driving position.*
 - *Nothing*
-

Matthew - Swansea **10/10**

- + *Improved comfort in comparison to older model. The increased range now allows for weekly charging instead of nightly.*
-

Andrew - Alloa **10/10**

- + *This is my second ZOE. The things I really like are the performance, interior and most of all the range. Console screen is excellent as are the reversing camera and all round sensors. New LED lights are superb.*
 - *No, no issues at all*
-

Lee - Aberdeen **10/10**

- + *Fun car to drive. Really clever full LCD dash and infotainment. Especially like the Apple CarPlay and google search for the Satnav. The companion app is also really clever and you can be anywhere with a phone signal. I really enjoy the near one pedal driving.*
 - *Nothing so far.*
-

Emma - Derbyshire **10/10**

- + *Every time I get in my ZOE, I can't help but grin. Great fun to drive. Fantastic range! Still adjusting to a three figure number for the range (this replaced a 24kWh Leaf that had 80,000 miles and would scrape 80 miles if driven very carefully. Love Joey the ZOE!*







More desirable than ever

ZOE shows off its character with expressive design, smooth lines, new C-shaped 100% LED lighting, fog lamps and a new distinctive grille. The new wider rear lights give a bold stance with an LED light beam that highlights the contours of the bodywork. Under the bonnet, you can opt for the new, more powerful, R135 motor, providing increased performance and driving pleasure, meanwhile, new B Mode increases regenerative braking and allows for a one-pedal driving experience.





A car designed for you

Ultra-connected to its surrounding world, ZOE is first and foremost connected to you. As soon as you approach ZOE, your hands-free card unlocks the doors to a car that combines technology with simplicity. The interior offers enhanced comfort with seat upholstery featuring recycled fabric ⁽¹⁾, with special attention given to sound insulation to provide an even more relaxing drive.

The dashboard is enhanced with its new 10" wide driver's screen, providing all the information you need when on the road, whilst the new steering wheel gives you control at your finger tips. Enjoy the brand new EASY LINK system, with a choice of 7"-9.3" screens and more connectivity than ever before.

(1) ICONIC seat upholstery is made from 100% recycled fabric, whilst GT LINE seat upholstery combines recycled fabric with synthetic leather.





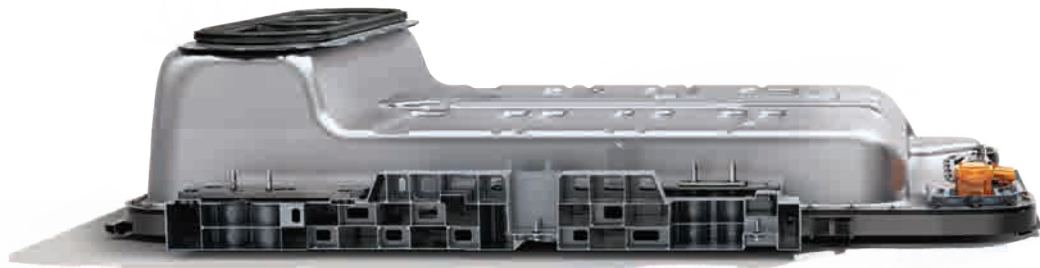

Z.E. 50 battery

Renault's Z.E. 50 battery stores 25% more energy than its predecessor, despite having exactly the same dimensions! With a driving range of up to 245 miles⁽¹⁾, you can travel further with confidence. Located under the floor to lower the centre of gravity, the battery has no impact on either the roominess of the car or the boot volume. With ZOE offering 100% torque from the moment you put your foot to the pedal, a quiet motor and no gear changes or petrol stations, you can enjoy great performance and a relaxed driving experience.



8 year battery warranty

For added reassurance and peace of mind, the traction battery on ZOE comes with an 8 year/100,000 mile warranty⁽²⁾, giving you confidence in our technology and on the road.

(1) PLAY R110 245 miles, ICONIC R110 and ICONIC R135 239 miles and GT LINE R135 238 miles. WLTP figures shown are for comparability purposes. Figures obtained after the battery was fully charged. Actual real-world driving results may vary depending on factors such as the starting charge of the battery, accessories fitted after registration, weather conditions, driving styles and vehicle load. Renault estimates average real-world driving figures for this vehicle as 233 miles in summer and 150 miles in winter, depending on the factors above.

(2) 8 year/100,000 mile traction battery warranty (whichever is reached first). For full Warranty Terms and Conditions please visit www.renault.co.uk/warranty.

Innovation for a better life

What is the purpose of innovation, if it doesn't offer a tangible benefit?

That's why all of ZOE's innovative features are specifically designed in order to make your electric life even easier.

Regenerative braking: Every time the driver brakes, the battery gets a boost of energy. This boost increases when you switch ZOE in to B Mode!

Heat pump: The heat pump is able to air-condition and heat your car more efficiently than a traditional system, meaning you can conserve more of your batteries energy for driving range.

Chameleon Charger™: Individual to Renault, the Chameleon Charger™ is always able to charge at the maximum power⁽¹⁾ available and is therefore quicker and more efficient, saving you time and money.

Pre-conditioning: Through our Connected Services⁽²⁾ you can pre-set the temperature of the car so it's ready for you before you get in. Warm in the winter and cool in the summer!

ECO Mode: When using the ECO Mode, the dynamic performance and air conditioning or heating is limited to maximize ZOE's driving range.

(1) For AC charging, between 3kW to 22kW.

(2) 3 years subscription to Connected Services for our 100% electric vehicles can be accessed through the MY Renault app. All models come with a 3 year subscription after which time they will need to be renewed. MY Renault and Connected Services are compatible with Apple iOS® and Android® devices.



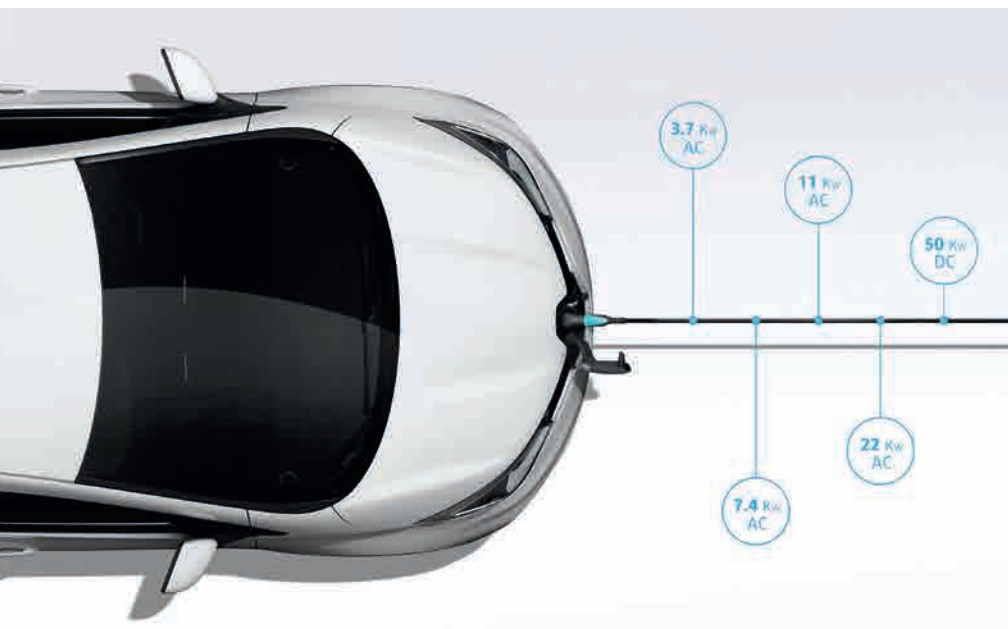

Battery and charging

Just like the other models in our electric range, ZOE is fitted with a lithium-ion battery, offering great performance. It is very simple to charge, even when it is fully discharged and it can also be recycled at the end of its life.

Thanks to The Chameleon Charger™ that is unique to Renault, ZOE is compatible with various power sockets and sources, providing you with a range of charging options. The result? Minimised charging times and maximised flexibility.

There are three easy ways to charge:

1. At Home. Charge at home from a 7kW charger that can fully charge ZOE overnight in 9-10 hours. With the new Z.E. 50 battery, ZOE can go even further so the majority of your charging will probably take place, hassle free, at home!

2. Destination. There are already over 11,000 public charging locations nationwide, that's more charging locations than petrol stations! The majority of these charging locations will provide a 3kW to 22kW charge and could charge your ZOE from 0-100% in as little as 3 hours⁽²⁾.

3. Rapid. These charge points are placed at key locations such as motorway services and have upwards of a 50kW capacity. They are ideal for long journeys and will charge your ZOE⁽³⁾ with Z.E. 50 battery from 0-80% in 1h 10, or if you are only making a brief stop, just 30 minutes charging will get you an extra 90 miles of range.

Not sure where to find chargepoints around you?

Use your EASY LINK navigation system or MY Renault App⁽¹⁾ to find local charge points or find charge points along your route.

(1) MY Renault is compatible with Apple iOS® and Android® devices and is available in the App store and Google Play® store.

(2) Based on 22kW charger.

(3) 50kW rapid charging capability is a payable option. See Renault Range Car Price Guide for further details.

The easiest way to charge your ZOE is at home...

Installing a home wallbox is the most convenient and most probably the cheapest way to charge your ZOE.

A 7kW home wallbox will charge a ZOE with Z.E. 50 battery from flat to full in 9-10 hours. Go to bed and wake up fully charged each morning, simply plug in and let ZOE recharge whilst you do the same!

Government Charging Grants⁽¹⁾

Electric Vehicle Homecharge Scheme

ZOE qualifies for the EVHS grant which provides 75% up to a maximum of £350 towards the cost of a home wallbox installation.

Workplace Charging Scheme

If you are requiring an install at your business, ZOE qualifies for the WCS grant which provides 75% up to a maximum of £350 towards the cost of a wallbox (for up to 40 sockets).

Wallbox installation

1. **Select your chosen wallbox and installer.** There are lots of different options available to suit all sorts of requirements, from aesthetics to solar compatibility - choose the one that's right for you and your ZOE.
2. **Contact & application.** Once you have decided on a wallbox and installer, contact them to begin your application. They should be able to explain the process to you and let you know what costs and timescales may be involved. They may ask you to send photos of your electrics and driveway or they may come and do a physical survey of your property themselves.
3. **Government grant.** If you are eligible for the government charging grants, the installer will claim this on your behalf and deduct the amount of the grant from your final bill. They may need you to fill in and sign paperwork in order to establish your eligibility.
4. **Confirmation.** Once all the surveys have been carried out and paperwork completed, your chosen installer should be able to give you a date to install your wallbox.
5. **Installation.** On the agreed day of installation, your chosen installer will send an engineer to fit the wallbox. Once completed, ask them to demonstrate how the wallbox operates to ensure you are confident when it comes to charging your ZOE for the first time.

How to choose a wallbox supplier?

To ensure the wallbox you choose is fully compatible with your Renault, we would recommend ensuring the wallbox and installer you use is certified by Renault as Z.E Ready. Your Renault dealership will be able to check this for you.



1) Exclusions and restrictions apply. For more information on the eligibility criteria for either of these schemes, please visit <https://www.gov.uk/government/news/update-on-the-infrastructure-grants-schemes>.

Driving Range

Now that ZOE is available with Z.E. 50 battery giving a WLTP* range of up to 245 miles on one charge, range anxiety is a thing of the past. With a real life estimate of 233 miles in summer and 150 miles in winter** ZOE is able to get you wherever you need to go with less need to recharge on the way, saving you time and money.

Range (miles)	PLAY R110	ICONIC R110/R135	GT LINE R135	Cost per mile ⁽¹⁾
WLTP*	245	239	238	3p
Summer (real-world estimate)	233	233	233	3p
Winter (real-world estimate)	150	150	150	5p

*What is the WLTP and why the real-life range is similar to it?

Worldwide Harmonized Light Vehicles Test Procedures (WLTP), this new homologation protocol gives fuel consumption and driving range results that are much closer to real life conditions figures than the NEDC protocol.

While the old NEDC test determined test values based on a theoretical driving profile, the WLTP cycle was developed using real-driving data, gathered from around the world. WLTP therefore better represents everyday driving profiles.

PLAY R110 245 miles, ICONIC R110 and ICONIC R135 239 miles and GT LINE R135 238 miles. CO₂ whilst driving: 0 g/km, MPG: n/a. Figures shown are for comparability purposes; only compare figures with vehicles tested to the same technical procedures. The electric range shown achieved using the new (WLTP) test procedure. Figures obtained after the battery was fully charged. Actual real-world driving results may vary depending on factors such as the starting charge of the battery, accessories fitted after registration, weather conditions, driving styles and vehicle load. Renault estimates average real-world driving figures for this vehicle as 233 miles in summer and 150 miles in winter, depending on the factors above.

**Why is the range reduced in winter?

Like all batteries, those in electric vehicles are less efficient in cold weather than at warmer ambient temperatures. This means that you can expect a reduction in the range of your electric vehicle during the winter. Also, in winter you are more likely to use the heating, which means ZOE consumes more energy. Summer and winter range estimates based on real-world driving data.

Charging times ⁽³⁾	PLAY R110	ICONIC R110/R135	GT LINE R135
7kW (0-100%)	9h 25	9h 25	9h 25
22kW (0-100%)	3 hours	3 hours	3 hours
50kW (0-80%)	N/A	1h 10	1h 10

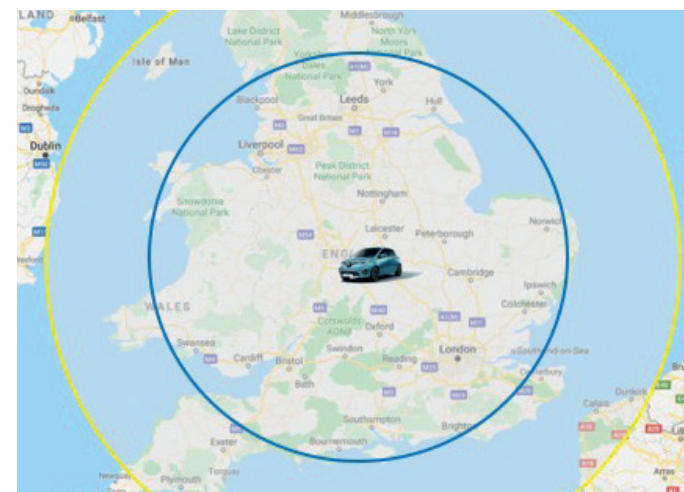

Illustrated range for ZOE with Z.E. 50 battery⁽²⁾ — Summer Range — Winter Range

This is the rate at which a home wallbox would usually charge. If you have a private driveway or designated parking space you should look into whether it is possible to get a home wallbox installed. Most people will charge at home, typically over night. The average adult needs 8 hours of sleep, so get your 8 hours in and by the time you are ready to leave the house, ZOE will be fully charged and ready to go!

On most journeys, there is no need to fully recharge and you will typically only top-up for half an hour at a motorway station. The perfect excuse for a cup of coffee.

Great if you are planning a longer journey! ZOE with rapid charge option can regain 90 miles of driving range in just 30 minutes of charging. Take a well earned break from driving and recharge at the same time as your ZOE.

(1) Recharge cost £7.48, based on 9.25 hours of 14.4p per kWh (Source: UK Power). Full recharge of the 52kW battery.

(2) For illustration purposes only, may not reflect real-life journeys.

(3) Charging time and recovered driving range depend on temperature, battery wear, the power delivered by the station, and your charge level.

Different Journey and Charging Scenarios⁽¹⁾

Everyone's daily schedules are different, however, ZOE with Z.E. 50 battery can now go even further and is suitable for a whole variety of journeys, short or long!

Multiple short journeys summer

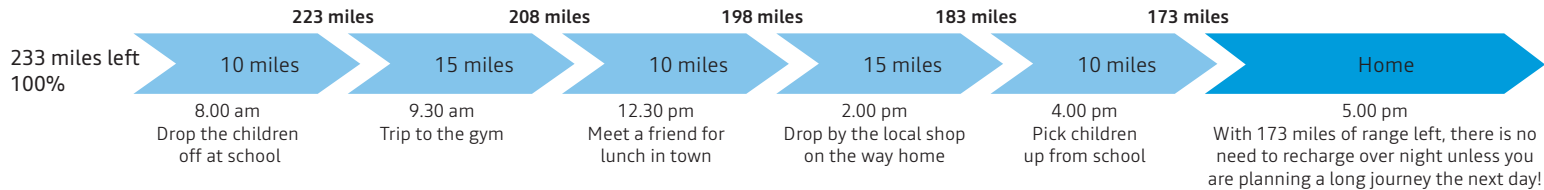

190 mile roundtrip trip summer

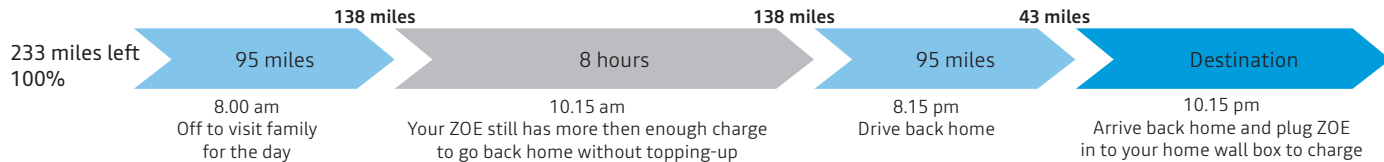

200 mile journey winter

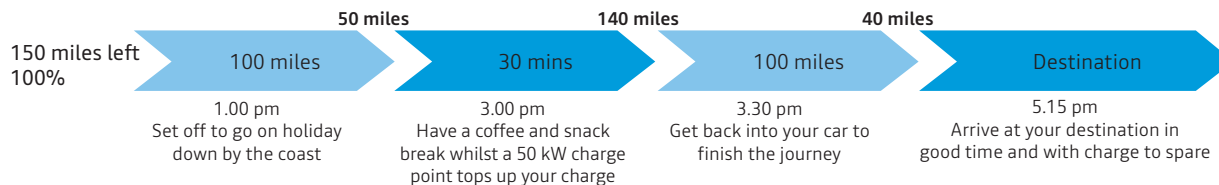

KEY

- Driving Distance
- Charging Time

Did you know that...

- ...the average daily mileage of people in the UK is just under 26 miles. Even if you drove triple that every day, you would not even come close to ZOE's limits.
- ...ZOE's unique AC Chameleon Charger™ is clever and can adapt to different chargepoints. It is always able to charge at maximum power and is therefore quicker and more efficient.
- ...there are many ways to maximize your range? ZOE's smart ECO Mode, driver coaching tips, and regenerative braking are all able to optimise your driving range.

(1) For illustration purposes only and based on the estimated driving range of ZOE with Z.E. 50 battery.



100% electric





Greater performance and more fun

If you love driving, then driving ZOE will be an absolute joy. With the option of the new R135 electric motor (134 hp), ZOE offers you a fantastic driving experience. With instant acceleration and more power, it makes motorway driving a breeze. Using the one-touch control on the new E-shifter gear selector, switch to B mode and try out a one-pedal driving experience and feed energy back to your battery at the same time!



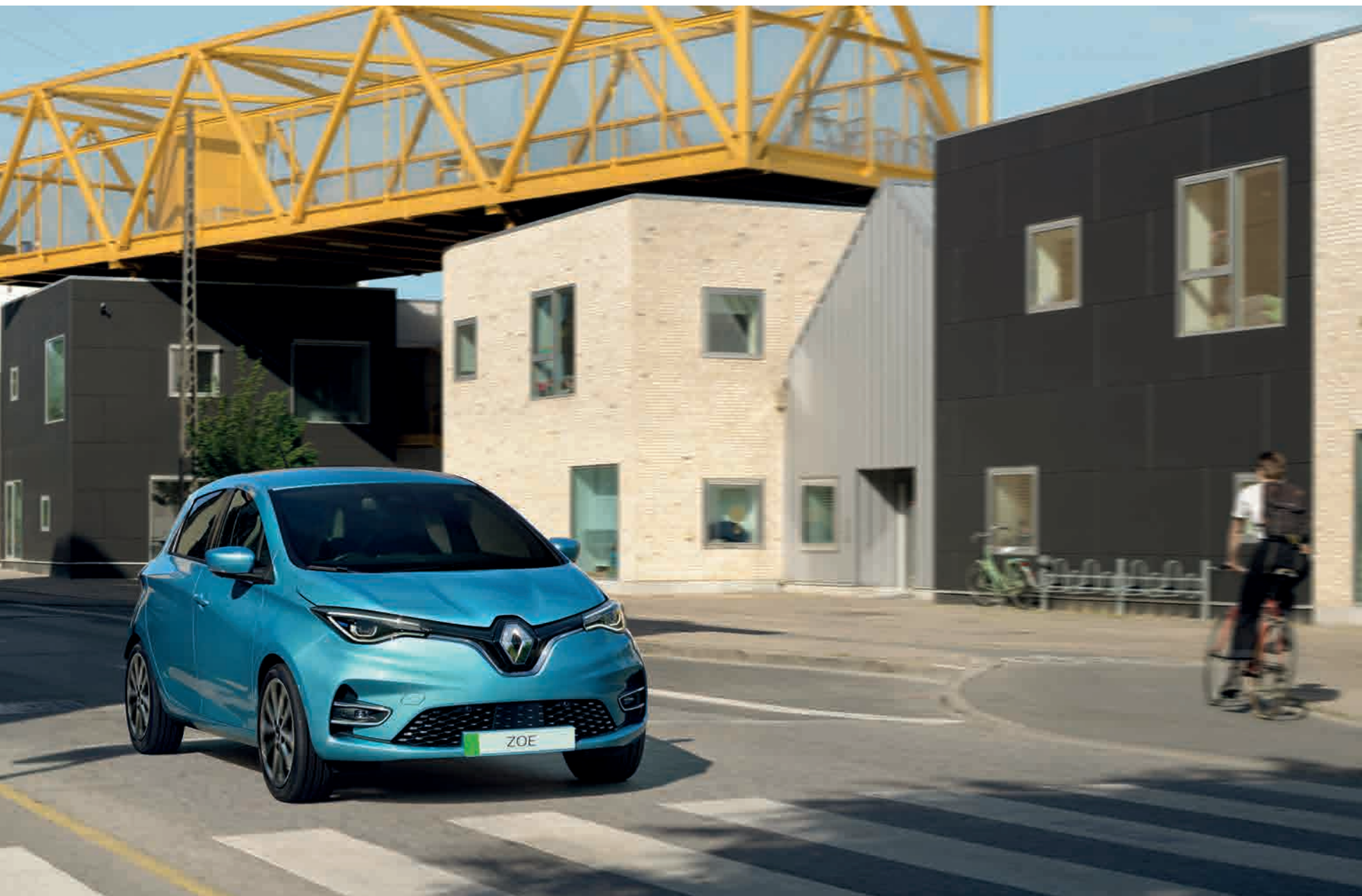



Truly connected

Listen to your favourite playlists, browse your applications and make calls easily, thanks to the new EASY LINK multimedia system, with a choice of 7" or 9.3" touch screens, both with Android Auto™ or Apple CarPlay™ as standard⁽¹⁾.

Directly connected to TomTom services, models with on-board navigation offer you a wealth of information in real time: traffic delays, weather, location of your nearest charging stations, and more. Unsure of your destination address? All you need are two or three keywords to find it using Google address search. Simple, fast and smooth, ZOE ensures you are truly connected at all points of your journey.

⁽¹⁾ Check your phone's capability at point of purchase with your dealer.

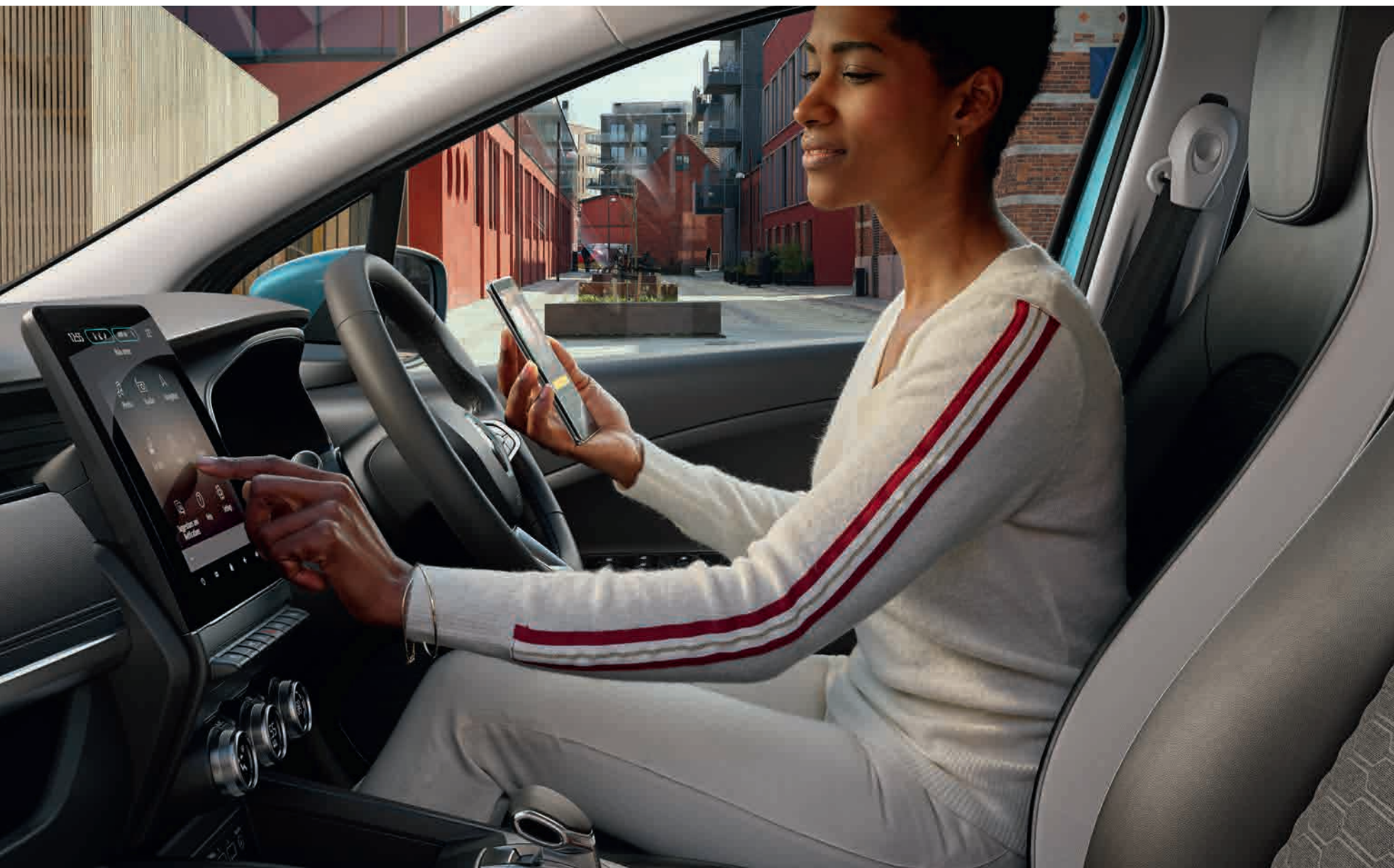





Take control of your car remotely with MY Renault

A 100% electric life is made easier thanks to the MY Renault app:

My car's location. Parked in an unfamiliar area? Find and be guided to the location of your ZOE using your MY Renault app. View your driving range and locate available charging stations nearby or at your destination.

Journey planner. Instantly prepare your journey on your smartphone: the application automatically includes stops at charging stations and takes into account charging times to calculate your arrival time. You just need one click to send the proposed route to Google Maps and then to the screen in your ZOE thanks to the smartphone replication.

Final mile guidance⁽¹⁾. Park up and transfer the route from your ZOE to your smartphone and easily continue on foot to your final destination.

Check the battery **charging status** and remaining driving range in real time.

Start or **schedule** to charge your ZOE at off-peak times to save on electricity costs.

Activate or **program the air conditioning** or **heating** in advance of your journey and enjoy ZOE at the perfect temperature when you get in.

(1) Available only on models equipped with EASY LINK navigation.

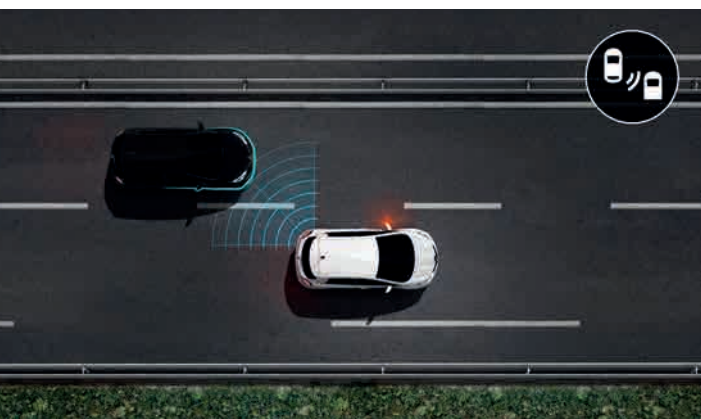
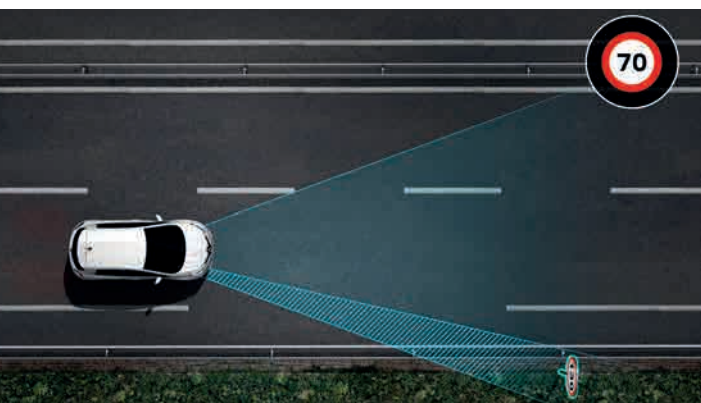
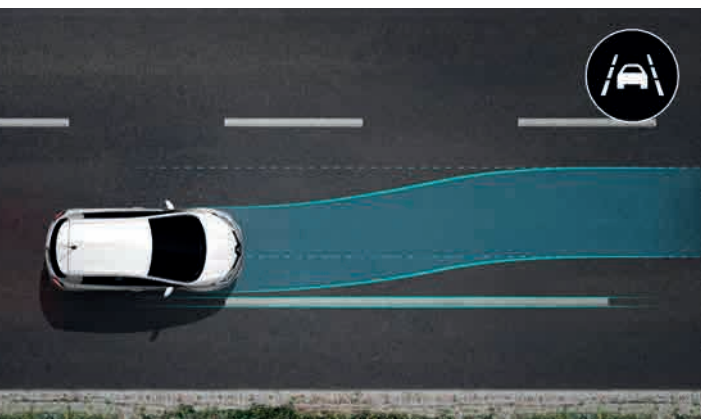

Driving made simple

Enjoy the many driving assistance aids⁽¹⁾ available as you move up the range on ZOE. On-board cameras identify speed limits for you, and the speeding alert advises you if you exceed the speed limit. ZOE detects any vehicle in or approaching your blind spot and advises you of its presence via a warning light on your door mirrors. Lane Keep Assist corrects your trajectory in the event you unexpectedly depart from your lane. ZOE makes your life easier with an ever more technologically advanced driving experience.

(1) It is your responsibility to stay alert, drive safely and be in control of the vehicle at all times. Driver assist features have speed and other limitations and should not be relied on. For more information, please refer to the owner's manual or contact your local dealer.





Colours





Celadon Blue⁽³⁾



Flame Red⁽³⁾



Aconite⁽³⁾



Diamond Black⁽²⁾

	Glacier White (369)	Quartz White (QNY)	Highland Grey (KQA)	Titanium Grey (KPN)	Celadon Blue (RQT)	Flame Red (NNP)	Aconite (LNJ)	Diamond Black (GNE)
Play	FOC	○	○	○	○	○	○	○
Iconic	FOC	○	○	○	○	○	○	○
GT Line	FOC	○	○	○	○	○	○	○

FOC = free of charge ○= Optional (1) Non metallic paint (2) Metallic paint (3) Renault i.d. metallic paint

Every effort has been made to ensure that the information, descriptions, and images were correct at the time of publication however images may not always reflect the exact version selected. It should be noted that limitations on screen do not permit the subtle paintwork shades on this page to be shown with absolute accuracy.

Standard features

PLAY



15" flex wheels



PLAY upholstery



Exterior design

- Full LED headlights with C-shape DRL
- 15" flex wheels
- Rear disc brakes
- Body-coloured door handles
- Black grain-effect door mirrors

Interior design

- Black PLAY seat upholstery

Driving and controls

- Hands-free key card with push button stop/start function
- Automatic head lights and rain sensitive front wipers
- Cruise control/speed limiter
- Customisable 10" driver's display
- R110 motor (80kW/107hp)

Comfort and convenience

- Automatic air-conditioning
- Driver and passenger front electric windows
- Heated electrically adjustable door mirrors

Communication and on-board technology

- EASY LINK radio with 7" touch screen
- Smart phone replication with Android Auto™ and Apple CarPlay™⁽²⁾

Z.E. specific equipment

- Z.E. 50 battery
- Eco-meter
- Pedestrian warning
- E-shifter gear selector with B mode
- Connected Services⁽¹⁾ via MY Renault App: battery charging status, charge scheduling and pre-conditioning
- Chameleon Charger™ for charging between 3kW to 22kW
- Type 2 charging cable

(1) 3 years subscription to Connected Services on all models after which time they will need to be renewed. Connected Services are compatible with Apple iOS® and Android® devices.

(2) Check your phones compatibility at point of purchase with your dealer.

Standard features

ICONIC (in addition to PLAY)



16" alloy wheels



ICONIC upholstery



Exterior design

- 16" alloy wheels
- Body-coloured door mirrors

Interior design

- 100% recycled fabric seat upholstery
- Synthetic leather steering wheel

Driving and controls

- R135 motor (100 kW/134 HP)
- Rear parking sensors
- Lane Departure Warning
- Lane Keep Assist
- Automatic High Low Beam
- Over Speed Protection
- Auto dimming rear view mirror

Comfort and convenience

- Split-folding rear bench
- Climate control
- Front and rear electric windows

Communication and on-board technology

- EASY LINK radio and navigation with 7" touch screen and 6 speakers
- 2 USB sockets for rear seats
- Connected navigation services - 3 years included: Google search for places of interest, live traffic info, weather, location of charging stations

Standard features

GT LINE (in addition to ICONIC)



16" diamond cut alloys



GT LINE upholstery



Exterior design

- Tinted rear windows and rear screen
- 16" diamond-cut alloy wheel
- Chrome stamped grille

Interior design

- GT LINE part recycled, part synthetic leather seat upholstery

Driving and controls

- Front and rear parking sensors
- Rear-view reversing camera
- Blind Spot Warning
- Active Emergency Braking System

Comfort and convenience

- Electrically folding door mirrors

Communication and on-board technology

- EASY LINK radio and navigation with 9.3" touch screen



Dimensions (mm)

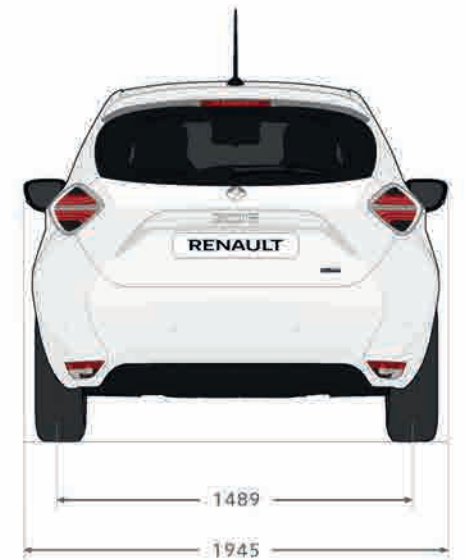
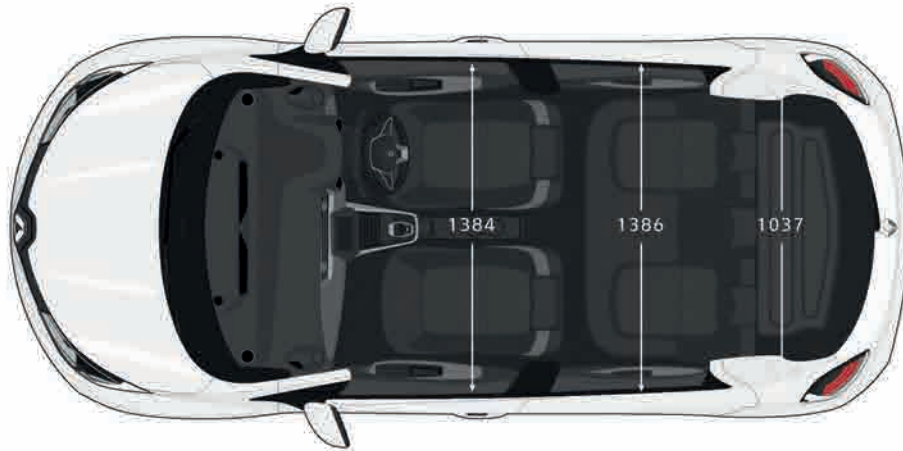
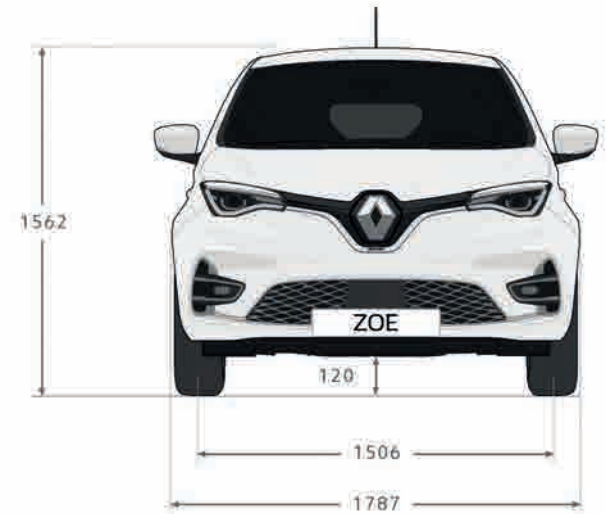
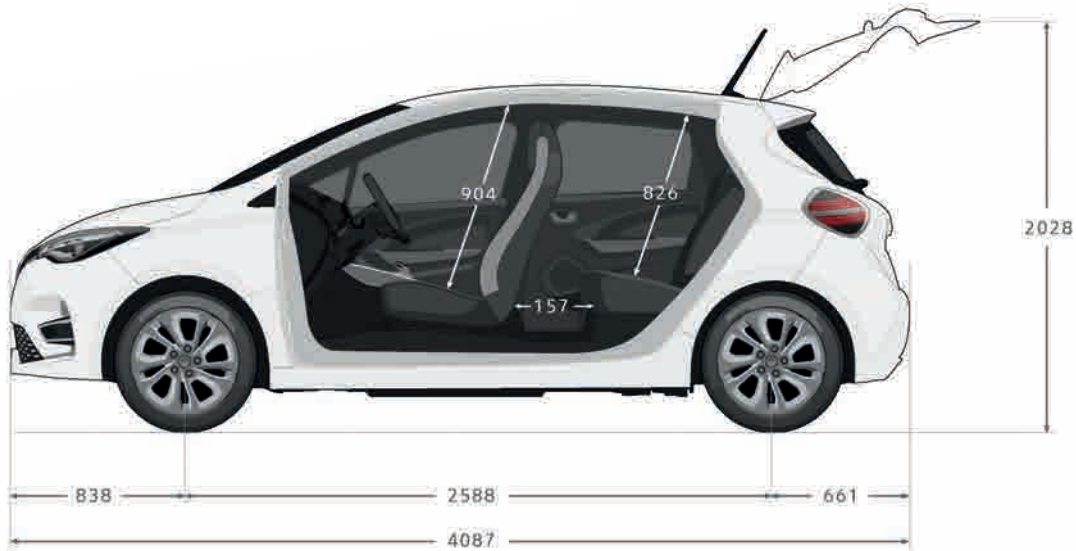

BOOT VOLUME (Litres)

Boot volume	338
Boot volume with rear bench seat folded	1225

Technical Specification

	R110	R135
Battery type	Z.E. 50	Z.E. 50
Number of seats	5	5
DRIVING RANGE & CONSUMPTION		
Certified WLTP (miles) ⁽¹⁾ combined cycle driving range	PLAY 245/ICONIC 239	ICONIC 239/GT LINE 238
Certified combined cycle consumption (Wh/km)	PLAY 173/ICONIC 178	ICONIC 178/GT LINE 179
Wheel size of the certified version ⁽²⁾	PLAY 15"/ICONIC 16"	16"
ENGINE		
Electric engine technology	Synchronous with wound rotor	Synchronous with wound rotor
Max. power output EEC kW (hp) / at peak power rating (rpm)	80 (108) / 3.395 to 10.886	100 (135) / 4.200 to 11.163
Max. torque Nm EEC (Nm) / at peak power rating (rpm)	225 / 500 to 3.395	245 / 1.500 to 3.600
BATTERY		
Usable capacity (kWh)	52	52
Technology	Lithium-ion	Lithium-ion
Total voltage (volts)	400	400
Number of modules / cells	12/192	12/192
Battery weight (kg)	326	326
CHARGING TIME⁽³⁾		
Charger	Adjustable single and three-phase, 2 kW to 22 kW	Adjustable single and three-phase, 2 kW to 22 kW
2.3 kW home outlet (single-phase 10A) (0-100%)	34h30	34h30
Green-up socket / 3.7 kW Wallbox (single-phase 16A) (0-100%)	16h10	16h10
7.4 kW Wallbox (single-phase 32 A) (0-100%)	9h25	9h25
11 kW station (three-phase 16A) (0-100%)	6h	6h
22 kW station (three-phase 32 A) (0-100%)	3h	3h
DC 50 kW quick charge (0-80%)	1h10	1h10
GEARBOX		
Gearbox type	Gearbox with a single gear ratio speed reducer	Gearbox with a single gear ratio speed reducer
Number of forward gears	1	1
PERFORMANCE		
Top speed (mph)	84	87
0-30 mph – 0-60 mph – 50-75mph (s)	3.9 - 11.4 - 9.3	3.6 - 9.5 - 7.1
SCx	0.75	0.75
STEERING		
Power	Yes (electric)	Yes (electric)
Turning circle between kerbs (m)	10.56	10.56
Number of steering-wheel turns	2.73	2.73
WHEELS AND TYRES		
Standard wheel rims (")	15" (PLAY) ; 16" (ICONIC)	16" (ICONIC/GT LINE) 17" (GT LINE)
Tyre dimensions 15" - Michelin Primacy 4	185/65 R15 92T	185/65 R15 92T
Tyre dimensions 16" - Michelin Primacy 4	195/55 R16 91T	195/55 R16 91T
Tyre dimensions 17" - Michelin Primacy 4	215/45 R17 91V (front) 205/45 R17 88V (rear)	215/45 R17 91V (front) 205/45 R17 88V (rear)
BRAKING		
Front: plain disc (PD), ventilated disc (VD) diam. (mm)	Ventilated discs 280	Ventilated discs 280
Rear: drum (D), plain disc (PD), ventilated disc (VD) diam. (mm)	Ventilated discs 260	Ventilated discs 260
WEIGHT (kg)		
Unladen kerb weight	1502	1502
Gross train weight (GTW)	1988	1988
Gross vehicle weight rating (GVWR)	1988	1988
Within the maximum permissible GVWR on front/rear	1048	1048
Payload (PL) (PLAY, no options / ICONIC & GT LINE models, all options)	425 / 474	425 / 486
Max. braked/unbraked trailer weight	Not permitted / Not permitted	Not permitted / Not permitted
SERVICE INTERVALS		
Service Intervals	12 months or 18,000 miles - whichever is sooner	

(1) PLAY R110 245 miles, ICONIC R110 and ICONIC R135 239 miles and GT LINE R135 238 miles. WLTP figures shown are for comparability purposes. Figures obtained after the battery was fully charged. Actual real-world driving results may vary depending on factors such as the starting charge of the battery, accessories fitted after registration, weather conditions, driving styles and vehicle load. Renault estimates average real-world driving figures for this vehicle as 233 miles in summer and 150 miles in winter, depending on the factors above. (2) The size of the wheel rims can impact the vehicle's driving range. (3) Charging time and recovered driving range depend on temperature, battery wear, the power delivered by the station and your charge level.

Equipment and options

	PLAY	ICONIC	GT LINE
SAFETY			
2 Driver airbags + 2 Passenger airbags	•	•	•
Hill Start Assist	•	•	•
Anti-lock Braking System (ABS) with Emergency Brake Assist (EBA)	•	•	•
Electronic stability programme (ESP) with anti-slip regulation (ASR) and understeer control logic (UCL)	•	•	•
Front fog lamps	-	•	•
Automatic headlights and wipers	•	•	•
Automatic activation of hazard lights upon emergency braking	•	•	•
R.A.I.D. (Renault Anti Intruder Device) automatic door locking	•	•	•
ISOFIX fittings on outer rear seats and front passenger seat	•	•	•
Tyre inflation and repair kit	•	•	•
Tyre pressure monitoring system	•	•	•
Z.E. Voice (low speed pedestrian warning)	•	•	•
DRIVING AND DRIVING ASSISTANCE			
Cruise control/speed limiter, with steering wheel controls	•	•	•
Customisable 10" colour driver's display	•	•	•
Rear parking sensors	-	•	•
Rear-view camera	-	○	•
Front and rear parking sensors	-	○	•
Active Emergency Braking System	-	○	•
Lane Departure Warning and Lane Keep Assist	-	•	•
Blind Spot Warning	-	-	•
Automatic high-beam/dipped-beam headlight activation	-	•	•
Over Speed Prevention	-	•	•
Auto dimming rear view mirror	-	•	•
COMFORT			
Automatic climate control with eco function	•	•	•
Front electric windows on driver and passenger side	•	-	-
Front & rear electric windows	-	•	•
Renault hands-free card	•	•	•
Heated, electrically adjustable door mirrors	•	•	-
Heated, electrically adjustable and folding door mirrors	-	-	•
Heated front driver and passenger seats and heated leather steering wheel	-	○	○
STORAGE			
Height and reach adjustable steering wheel	•	•	•
Glovebox with slow-opening flap	•	•	•
1.5L bottle holders in front doors	•	•	•
Map pockets on back of passenger seat	-	-	•
Split-folding rear bench	-	•	•
TECHNOLOGY			
Easy Link 7" - Radio with 7" high resolution touch screen - Compatible with Android Auto™ and Apple CarPlay™ - Bluetooth®, 2 USB, 1 AUX port	•	-	-
Easy Link 7" with Navigation - Radio and navigation with 7" touch screen, compatible with Android Auto™ and Apple CarPlay™ - 6 speakers, Bluetooth®, 2 USB, 1 AUX port, Connected navigation services, Auto-Update Service	-	•	-
Easy Link 9.3" with Navigation - Radio and Navigation with 9.3" high resolution touch screen - Compatible with Android Auto™ and Apple CarPlay™ - 6 speakers, Bluetooth®, 2 USB, 1 AUX port - Connected navigation services - Auto-Update Service	-	-	•
2 USB ports in rear	-	•	•
12V outlet under the dashboard	•	•	•
RENAULT EASY CONNECT - CONNECTED SERVICES			
4G connected vehicle with data pack included for 3 years	•	•	•
Connected navigation services - 3 years included: Google search for places of interest, live traffic info, weather (depending on the country)	-	•	•
Connected services on the MY Renault app: battery charging status, passenger compartment preconditioning	•	•	•
Auto-Update service - 3 years included (for compatible Easy Link systems): automatic wireless updating of the multimedia system, for automatic system improvements. For Easy Link systems with navigation: map also updated automatically	-	•	•

	PLAY	ICONIC	GT LINE
Z.E. SPECIFIC EQUIPMENT			
ECO Mode	●	●	●
Odometer, eco-meter and battery gauges integrated into the instrument panel	●	●	●
Scheduled charging and heating or air conditioning using the EASY LINK multimedia system	●	●	●
Chameleon Charger™	●	●	●
50kW DC rapid charger	-	●	●
Type 2 charging cable	●	●	●
EXTERIOR DESIGN			
Full LED headlights with C-shape DRL	●	●	●
Chrome stamped grille	-	-	●
Tinted rear windows and rear screen	-	-	●
15" flex wheels with 15" Michelin Primacy 4-E tyres	●	-	-
16" alloy wheel with 16" Michelin Primacy 4-E tyres	-	●	-
16" diamond-cut alloy wheel with 16" Michelin Primacy 4-E tyres	-	-	●
Rear disc brakes	●	●	●
Metallic paint	○	○	○
Body-coloured door handles	●	●	●
Black door mirrors with grain-effect	●	-	-
Body-coloured door mirrors	-	●	●
INTERIOR DESIGN			
Leather gear lever	●	●	●
PLAY black fabric seat upholstery	●	-	-
ICONIC 100% recycled fabric seat upholstery	-	●	-
GT LINE part recycled fabric, part synthetic leather seat upholstery	-	-	●
Synthetic leather steering wheel	-	●	●
OPTIONS			
TECHNOLOGY			
Safety Pack (AEBS, front & rear parking sensors with rear-view reverse camera)	-	○	-
INTERIOR			
Winter Pack (heated seats & heated leather steering wheel)	-	○	○
EXTERIOR			
Metallic Paint	○	○	○
Metallic Renault i.d. paint	○	○	○

● : Standard. ○ : Option. - : Not available. (1) 17" Alloy wheel option will reduce WLTP driving range to 224 miles.

EASYLIFE SERVICE PLAN

3 Years / 30,000 miles

4 Years / 40,000 miles

*The EasyLife Service Plan offer is available for all retail vehicles and valid at participating dealers only or Renault.co.uk and can be purchased up to 12 months after registration or before the first service (whichever is sooner). Vehicles must be ordered between 4 January 2021 and 31 March 2021 and registered by 30 June 2021. **The EasyLife Service Plan is available for eligible retail vehicles on a 36 or 48 monthly payment option and are only available at point of signing a finance agreement provided by Renault Finance. Rivers Office Park, Denham Way, Rickmansworth, WD3 9YS. Guarantees and indemnities may be required. You must be a UK resident (excluding the Channel Islands) and over the 18 to apply for finance. Terms & Conditions apply.

The Renault Service plan covers the manufacturer's minimum maintenance programme requirements for the term of the Service Plan purchased (refer to the Warranty and Service sheet in the Handover Document wallet for details). The plan ends when you reach the age or mileage limit (whichever comes first). Services must be carried out in line with the manufacturer's minimum maintenance programme requirements and servicing intervals within +/-1 month or 1,000 miles of the service interval and can only be carried out at a Renault Approved outlet. Service plans do not cover wear and tear items such as (but not limited to) tyres, wiper blades or brakes. For Service plan full Terms & Conditions visit www.renault.co.uk/owners. Cannot be part exchanged, refunded or transferred. All prices quoted are MRRP.

For prices, please refer to the Renault Car Price Guide available at your local dealer and on www.renault.co.uk.

Accessories



1. Boot Cable Storage

Fully integrated in to the boot of your ZOE, the Boot Cable Storage accessory offers several compartments to reduce clutter and create additional storage. Giving sufficient space to store up to 2 charging cables, the removable floor is hinged and includes a handle for easy access with a compartment also added to protect the optional BOSE® subwoofer.

2. Shark Antenna*

Add a sporty touch with the Shark Antenna, perfectly integrated in to the roof of your ZOE. Compatible with digital audio broadcasts (DAB).

3. Domestic Charging Cable

For use in the absence of a Wall-Box or Public Charging Point, ZOE can be charged using the domestic charging cable from a 3 pin domestic plug. Length: 6.5m & Maximum Current: 10A.

4. Illuminated 'RENAULT' Door Sills**

An elegant and modern touch every time you open the door of your ZOE. Finished with the RENAULT logo, these stainless steel and aluminium finished door sills also protect your vehicle's door sills from damage.

*Also available in a non-illuminated version

5. Boot Sill Protector

Cover and protect your vehicle's rear bumper with a practical, tailor-made aesthetic accessory. In chrome, it provides a design touch at the rear of your vehicle.

*This accessory requires registration of the vehicle before fitment.

**Also available in a non-illuminated version.

Accessories are fitted post-production and may have an impact on real world fuel (actual) consumption and CO₂ figures.

For more information, consult the ZOE accessories brochure. For prices, please refer to Renault Car Price Guide





Renault Services

5 Years Warranty

Your ZOE is covered by a warranty package for up to 5 years^o from date of first registration with unlimited mileage during the first 24 months, then limited to a total of 100,000 miles or 5 years, whichever comes first. Your Renault Z.E. Dealer is able to repair or replace without charge, parts that are found to have a material or assembly defect that is recognised by Renault. The traction battery warranty runs for 8 years^y or 100,000 miles, whichever comes first. The paintwork warranty runs for 3 years and the anti-corrosion warranty for 12 years^o.

3 Years Roadside Assistance

Should you need it, we'll provide emergency roadside repairs or tow you to the nearest Renault Dealer. This service is available 24 hours a day and is provided for 36 months from the date of first registration (unlimited mileage for first 24 months, then limited to a total of 100,000 miles or 3 years, whichever comes first). Assistance is provided within the UK & Northern Ireland only at roadside, home and includes national recovery and onward travel. Renault Assistance applies to mechanical or electrical defects which are covered by warranty.

For Renault Assistance Terms and Conditions please visit www.renault.co.uk/assistance.

EasyLife Service Plan

Renault's EasyLife Service Plan is the ultimate package to provide care free servicing for the first 3 years or 30,000 miles (whichever is sooner). It really is the hassle free way to take care of our Renault and benefits from;

- Inflation Proof Servicing - You know exactly what you'll pay and there are no hidden costs
- Peace of Mind - No matter where life takes you, we'll be there in over 5000 workshops across Europe
- Renault Expertise & Quality - Our highly trained technicians know your Renault inside out

The EasyLife Service Plan contains Renault services in-line with the manufacturer's service schedule, plus comes with a complimentary vehicle health check to ensure your Renault is in the best condition possible.

EasyLife servicing and warranty enhancements also available. Refer to the Price Guide for more details.

One off* and monthly** payment options available.

o5-year warranty valid on ZOE. Exclusions and limitations apply. For Warranty Terms and Conditions please visit www.renault.co.uk/warranty. *The EasyLife Service Plan offer is available for all retail vehicles and valid at participating dealers only or Renault.co.uk and can be purchased up to 12 months after registration or before the first service (whichever is sooner). Vehicles must be ordered between 4 January 2021 and 31 March 2021 and registered by 30 June 2021. **The EasyLife Service Plan is available for eligible retail vehicles on a 36 or 48 monthly payment option and are only available at point of signing a finance agreement provided by Renault Finance. Rivers Office Park, Denham Way, Rickmansworth, WD3 9YS. Guarantees and indemnities may be required. You must be a UK resident (excluding the Channel Islands) and over the 18 to apply for finance. Terms & Conditions apply. ***Finance provided by Renault Finance, P.O. Box 149, Watford, WD17 1FJ. Guarantees and indemnities may be required. You must be at least 18 and a UK resident (excludes Isle of Man and Channel Islands) to apply. Subject to status, terms and conditions apply. †Calls to 0330 numbers are free if used as part of your inclusive mobile minutes and are charged at local rates from landlines. †If your insurer uses non-approved parts which subsequently fail, they may not be covered under your manufacturer's warranty. ‡For full warranty terms and conditions please visit www.renault.co.uk/warranty. †Renault Insurance is arranged and administered by Verex Insurance Services Ltd, which is registered in England and Wales No. 05686831 at Batchworth House, Church Street, Rickmansworth, Herts, WD3 1JE and authorised and regulated by the Financial Conduct Authority, No. 487185. Verex Insurance Services Ltd arranges policies from a panel of insurers, details are available on request.

Finance options***

There are a wide variety of ways in which the purchase of a new vehicle can be financed. Renault Finance offers all of them, so whether you're a fleet buyer or private buyer, Renault Finance is ideally placed to tell you which plan or combination of plans best suits your needs and circumstances.

Renault car insurance¹

A car as well designed as your Renault deserves an insurance policy to match. Renault Insurance has been specifically created to provide superb protection for you and your car. Unlike most other UK insurers, in the event of an accident, Renault Insurance will have your Renault repaired at a Renault Approved Bodyshop using only Renault approved parts and approved repair methods. This maintains your Renault's safety rating, protects its resale value and preserves its Renault warranty^o. Renault Insurance also offers a courtesy car for the duration of a repair at a Renault Approved Bodyshop.

Renault car insurance: **0330 102 7794[†]**
www.renaultcarinsurance.co.uk

Lines are open Mon - Thurs 8.30am - 7pm, Fri 9am - 6pm, Sat 9am - 5pm

Renault iCare

Is an innovative Service, Maintenance & Repair product that supplies Business customers with a fully supported, managed hassle free service and maintenance package.

Renault iCare is a "Pay-As-You-Go" product that insures your vehicle is maintained by Renault technical experts when work is required.

iCare provides the following benefits:

- Full Service, Maintenance & Repair cover in the Renault Dealer Network
- Tyres can be included within the contract at an additional fixed cost
- Ancillary equipment can also be included (at an additional fixed monthly cost)
- Excludes: Damage/Neglect/Abuse/Glass & Bulbs

- A fixed, pre-agreed pence per mile rate
- No excess mileage charges at the end of the contract
- No pooled mileage administration
- Minimalise downtime

For more information and to obtain a quote based on your requirements, please speak to your local Renault Business dealer or visit www.renault.co.uk/care.

Customer Relations

Renault knows the value of communicating with its customers and we have established effective ways to keep in touch with you. If after speaking to your local Renault dealership you are not completely satisfied, please contact the Renault UK Customer Relations Team on 0344 3350000[†] (Mon-Fri 8.00am to 6.00pm. Closed on Bank Holidays. Live Chat Mon-Fri 8.00am to 9.00pm). You can also visit our website www.renault.co.uk or write to us at: Renault UK Ltd, The Rivers Office Park, Denham Way, Maple Cross, Rickmansworth, Hertfordshire, WD3 9YS.



Continue the Renault ZOE experience
at www.renault.co.uk

*Best selling based on cumulative sales across Europe since being launched in 2012.

Although every effort has been made to ensure that the information contained within this brochure is as accurate and up to date as possible, Renault U.K. reserves the right to modify its models without notice, including their characteristics, specifications, equipment and accessories. Brochures inevitably become out of date or inaccurate in some respects, in that such characteristics, specifications equipment, or accessories may be changed after the publication date given below and can differ from the descriptions given or the photos displayed. It is therefore necessary to check with your Renault Dealer before purchasing any product that the characteristics, specifications, equipment or accessories of the vehicle on order are as advertised.

 Prodigious

Photo credits: F. Ohm, Additive Studios, ©Renault Marketing 3D-Commerce – 7701 380 801 – May 2021